

ACTIVENT System

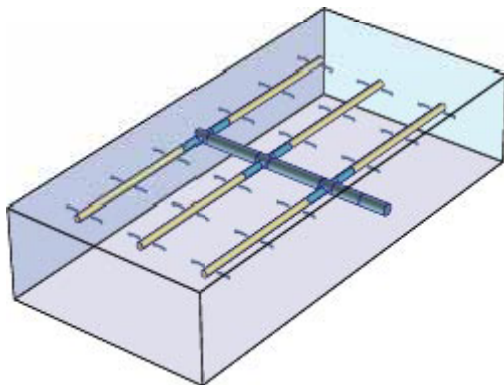

Activent's performance benefits

Activent is a ventilation system for supplying and distributing air. The system has been proven to function effectively in both small and large areas and is used in all types of premises ranging from offices and schools, to department stores and industrial facilities.



Distributing area through large areas

Activent utilises special ducts equipped with a large number of small nozzles that evenly distribute air along the entire length of the duct. The small jets from the ducts mix with room air through induction and set large masses of air slowly into motion. Due to the effective mixing technique, air can be supplied at a temperature much cooler than room air, without causing draughts. When under-tempered air is supplied, a cool mass of air forms around the Activent nozzle duct and slowly settles cooling the room air.

The Activent System can supply a major cooling effect using less supply air than conventional systems.

Overview of the Activent System

The Activent System consists of a nozzle duct that comes in five different sizes: 020, 025, 031, 040 and 050. The size indicates the diameter of the nozzle duct in cm.

If the duct is viewed in cross-section, the protruding nozzles are arranged in sectors of varying width ranging from 60° to 360° encircling the entire duct.

The system includes fittings such as extension ducts, end caps, T-ducts, sleeves and transition pieces. All parts can be ordered in the same colour as the Activent.

A selection of specially designed fittings is also available for installing Activent, such as brackets for suspending the nozzle ducts from the ceiling, suspension rods and other parts.

Design assistance

In addition to this technical brochure, HVAC designers can use Activent computer software for designing complete installations, include sound calculations.

Why you should choose Activent?

- Effective ventilation throughout the entire room space.
- Even temperature throughout the occupied zone.
- Excellent control - air flow and temperature control can be varied within a wide range without causing uncomfortable draughts.
- Substantial cooling effect with low air flows.
- Low air velocities in the occupancy zone.
- Simple duct installation.
- Easy to adjust and fine tune.

Standard nozzle sectors

Upwards

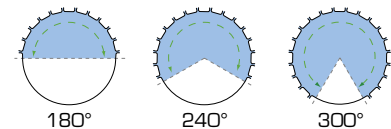

Sideways

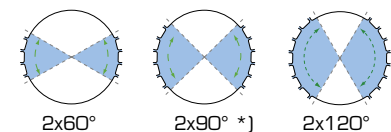

*] Only in sizes 031, 040 and 050.

Downwards

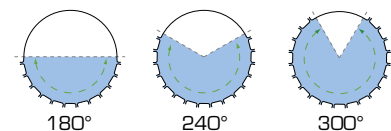

Full circular

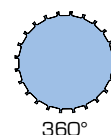

Select the right Activent

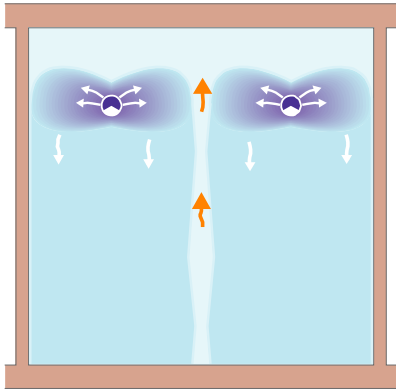

Upwards distribution

The most common Activent application. Upwards distribution is suited for most types of premises and VAV systems. Excellent control: both the temperature and air flow can be varied by a wide margin.

** A much higher cooling effects can be obtained in premices with lower comfort requirements, for example, when cooling hot workplaces in industrial facilities where high air velocities can be accepted.*

	Min	Max	Normal
Distance between ducts, m	1,5	15	2-5
Installation height, m	2,2	5	3-3,5
Clearance from ceiling, m	0,2		
Δt room-supply air, °C	1	15	4-12
Cooling effect, W/m ²		200*	<90

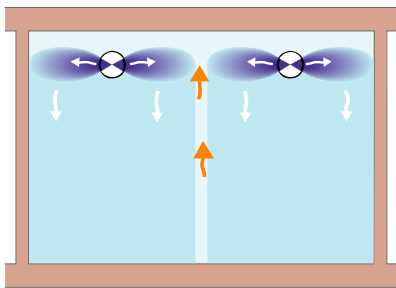

Sideways distribution

A suitable arrangement in premises with low ceilings. We normally recommend using the 2 x 120 nozzle sector. The 2 x 60 nozzle sector has a longer throw and therefore requires a longer distance between nozzle ducts.

	Min	Max	Normal
Distance between ducts, m	2,5	15	3-5
Installation height, m	2,2	3,5	2,5-3
Clearance from ceiling, m	0,1		0,1-0,2
Δt room-supply air, °C	0	8	0-4
Cooling effect, W/m ²		60	<25

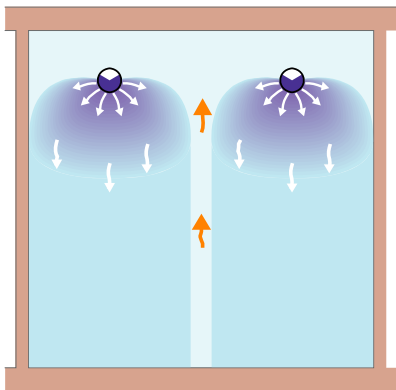

Downwards distribution

This application is recommended when the ceiling is higher than 3,5 m and when a lower subtemperature is used. This installation method is also preferred for ventilating individual workplaces. Risk for high air velocities when supplying cool air.

** A much higher cooling effect can be obtained in premices with lower comfort requirements, for example, when cooling hot workplaces in industrial facilities where high air velocities can be accepted.*

	Min	Max	Normal
Distance between ducts, m	1,5	15	2-5
Installation height, m	2,5	8	3,5-5
Clearance from ceiling, m	0,1		
Δt room-supply air, °C	1	10	3-8
Cooling effect, W/m ²		190*	<30

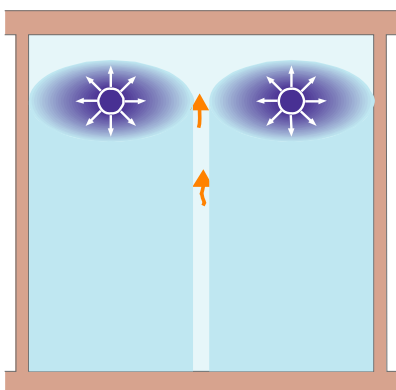

Full circular distribution, 360°

For very large, isothermal air flows in laboratories and similar premises where fume hoods require a large amount of replacement air. Comparable with perforated ceilings when the distance between Activent is 2-4 x diameter.

	Min	Max	Normal
Distance between ducts, m	1,5	15	1,5-3
Installation height, m	2,2	5	2,5-3
Clearance from ceiling, m	0,2		
Δt room-supply air, °C	0	4	2-3
Cooling effect, W/m ²		<100	<30

Design tips and definitions

Straight extension before Activent

Activent nozzle ducts should not be positioned too close to dampers, bends, T-piece and other objects that might create turbulence and, consequently, noise. Straight extension ducts should be installed between ducts and possible sources of disturbance, according to the recommendation below. Suitable extension ducts can be supplied.

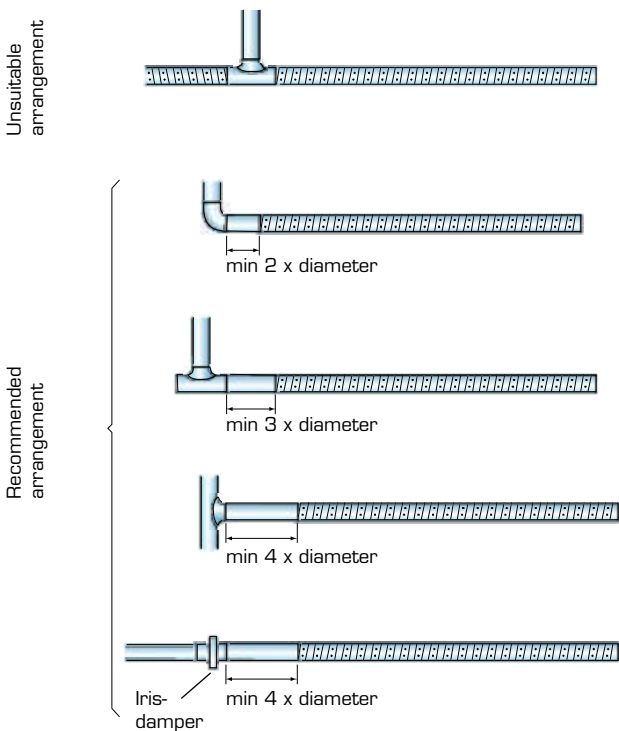

Straight extension before dampers

If flow measurement is required over dampers, a straight extension duct must also be installed before the damper. Normally, the air flow is measured by means of the nozzle pressure.

Definitions

A = Distance between Activent units, not the distance between Activent and extension ducts, See table on page 3.

M = Air supply to an Activent unit.

l = Activent length. If the Activent is divided into several sections, you define the maximum Activent length as the sum of the different duct sections. In the example, the maximum Activent length is 6 m.

Measuring the air flow

The simplest way to measure the air flow is to measure the nozzle pressure in the centre of the nozzle duct. You measure the nozzle pressure by attaching the hose from the pressure meter to one of the jet nozzles and reading the pressure. Assume that your reading was up to 25 Pa. Then consult the Activent diagram and find the dimension and nozzle sector for the installation in question. Here you can read the flow that the actual pressure gives per meter of duct. You obtain a flow in litres per second and per meter of duct. Then multiply the flow by the length to obtain the total flow through the nozzle Activent.

Selecting large nozzle sectors

It is better to choose a large nozzle sector than a small one. You should preferably base your dimensioning work on the 240-degree nozzle sector, since it has a good combination of properties with long permissible Activent lengths and a relatively high air flow.

Special range

We can also manufacture Activent nozzle ducts with 60°, 120°, 210° and 270° nozzle sectors in the sizes 031, 040 and 050. However, you can always meet air flow requirements with standard sizes.

Exhaust air devices

Exhaust air devices are preferably installed above Activent nozzle ducts in most types of installation arrangements.

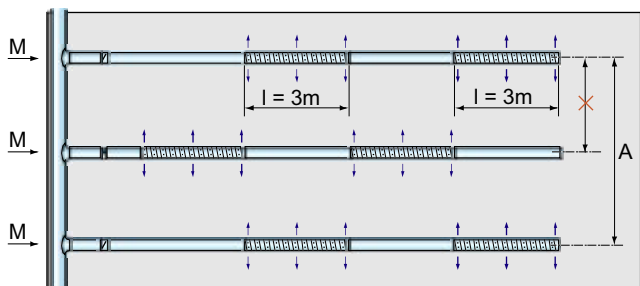

Alternative Activent arrangements

Depending on local conditions, Activent nozzle ducts can be arranged in different ways. Here are a few examples.

Staggered model

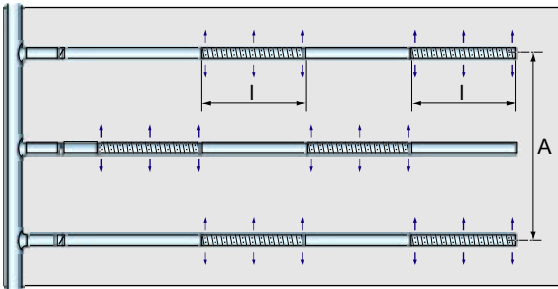

A suitable solution for long, narrow areas where the maximum Activent length is insufficient. Extension ducts are installed between the Activent ducts for good air distribution throughout the area

Tree model

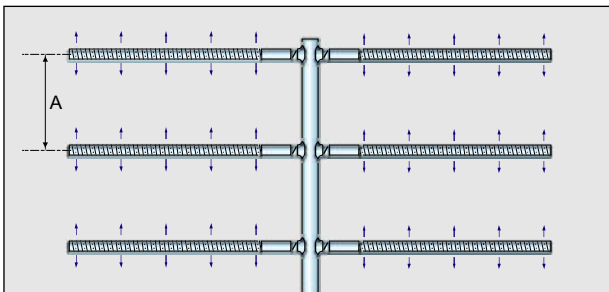

Activent nozzle ducts extend from both sides of the main duct. Control dampers are recommended for precise adjustment of the air flow.

Long length model

A simple solution that makes the installation of ducts easy and minimises the number of control dampers. The distance between each air duct is 2 times the maximum duct length and extension duct.

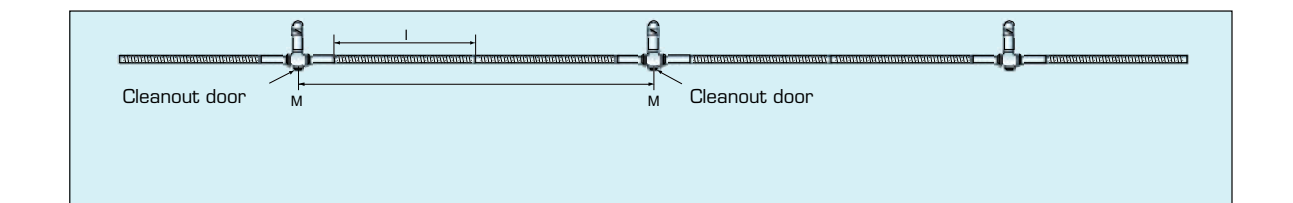

Fork model

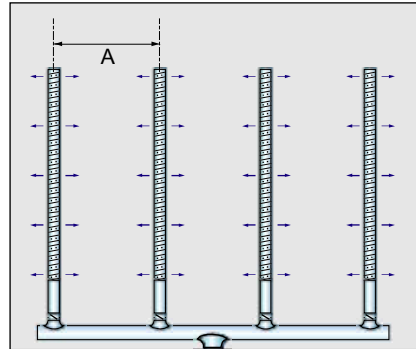

Activent nozzle ducts extend from one side of the main duct. Control dampers can be used for precise adjustment of the air flow.

Cactus model

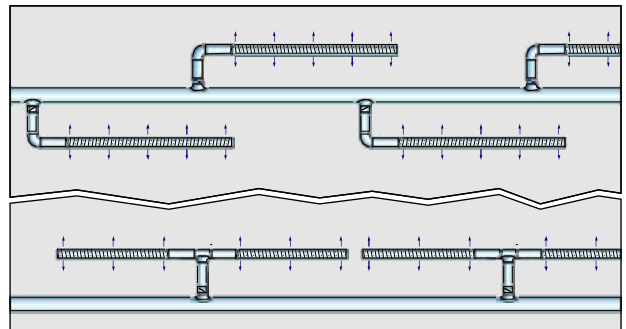

This arrangement is used for long, narrow rooms where the staggered model will be insufficient for covering the entire length of the room.

Dimensioning

Air velocities in the occupied zone

If there are high demands for comfort, the air velocity should be calculated and verified with our computer software, Activent for Windows. Contact your nearest Fläkt Woods office.

VAV systems, nozzle pressure and temperature

When Activent is used in ventilation systems with variable air flow, it can be dimensioned for a maximum nozzle pressure of 50 Pa at a maximum air flow in size 020 and 025. The maximum nozzle pressure is 70 Pa for Activent nozzle ducts in size 031, 040 and 050. The air flow can be controlled down to a nozzle pressure of 50 Pa, without compromising the air distribution pattern.

The temperature of the supply air can also be controlled. However, heat cannot be distributed with the supply air. When heating is desired, Activent should be supplemented with, for example, the Dirivent System.

Maximum Activent length

The maximum Activent length in the diagrams must be observed. If the maximum length is exceeded, air will be improperly distributed above the duct and the given sound levels cannot be obtained. If the Activent is divided into several sections, the total Activent length applies.

Dynamic pressure

The static pressure is given in the diagrams. To calculate the total pressure requirement, you need the dynamic and static pressure according to:

$$\Delta p_t = \Delta p_s + p_d \quad (1/2 \rho v^2), \text{ where}$$

p_s = nozzle pressure

v = the inlet velocity to the duct and

ρ = density of the air in kg/m^3 .

Activent nozzle ducts, size 020, diameter 200 mm

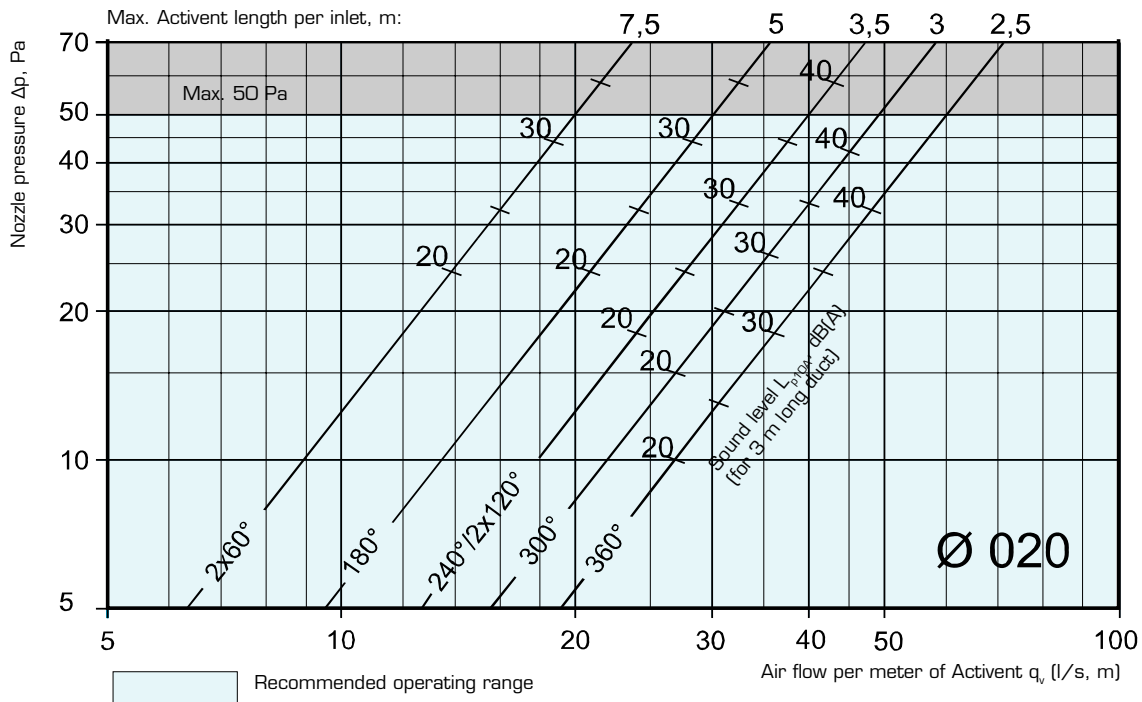

Dimensioning

Activent nozzle ducts, size O25, diameter 250 mm

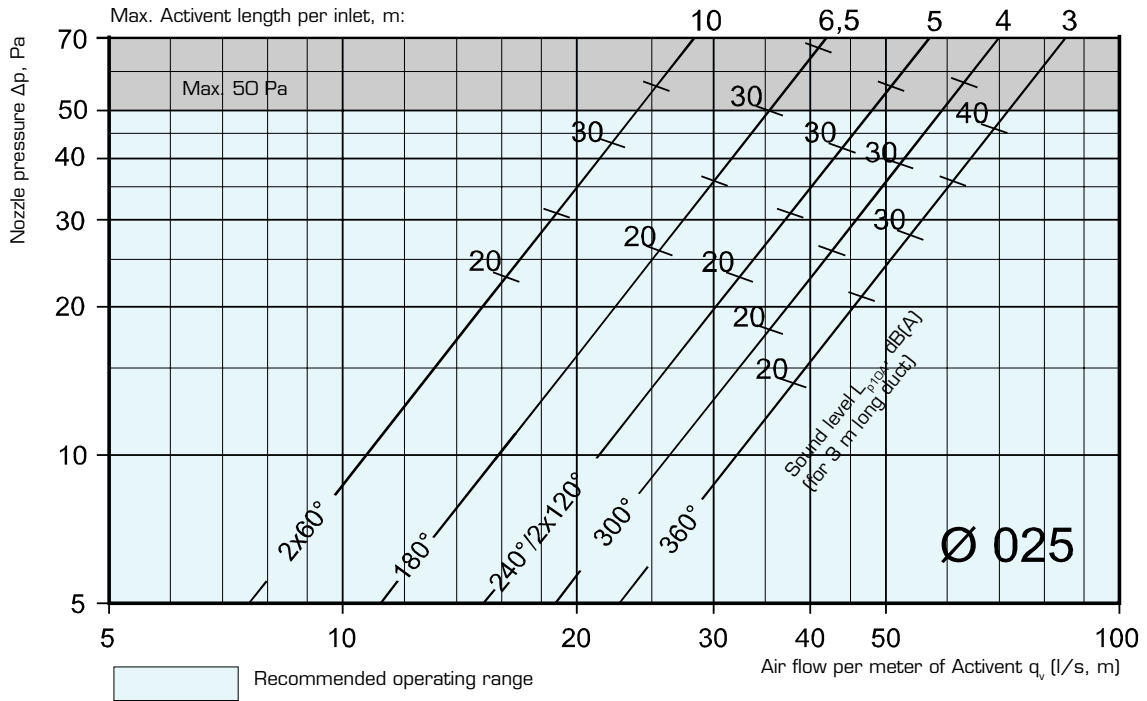

Activent nozzle ducts, size O31, diameter 315 mm

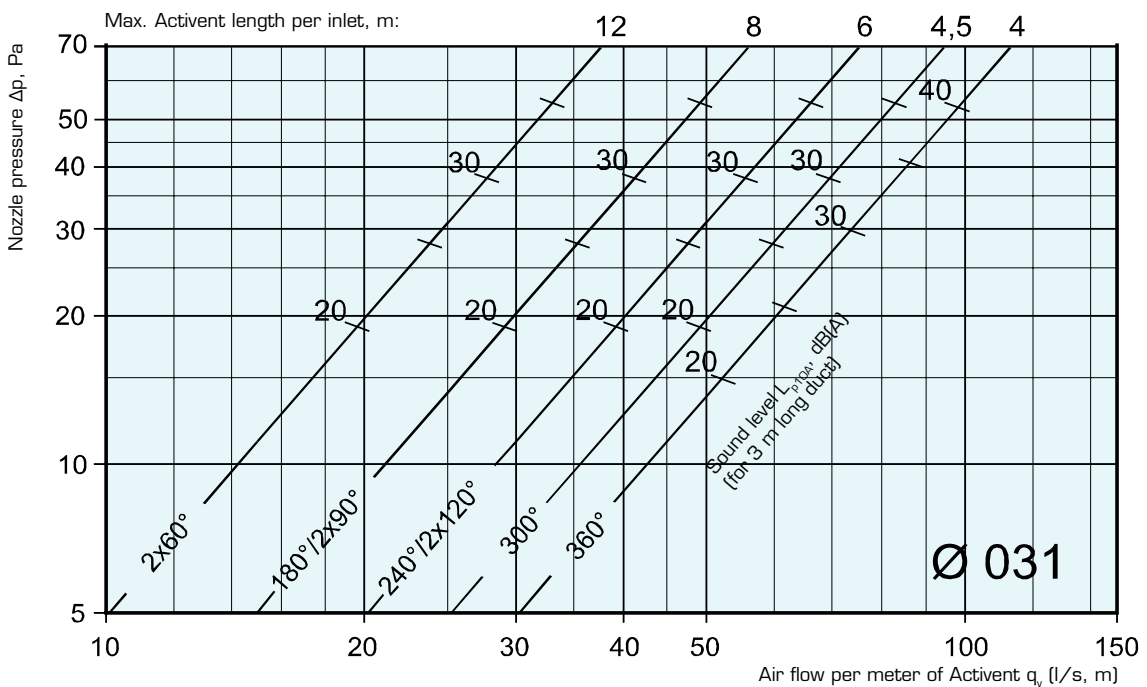

Dimensioning

Activent nozzle duct, size O40, diameter 400 mm

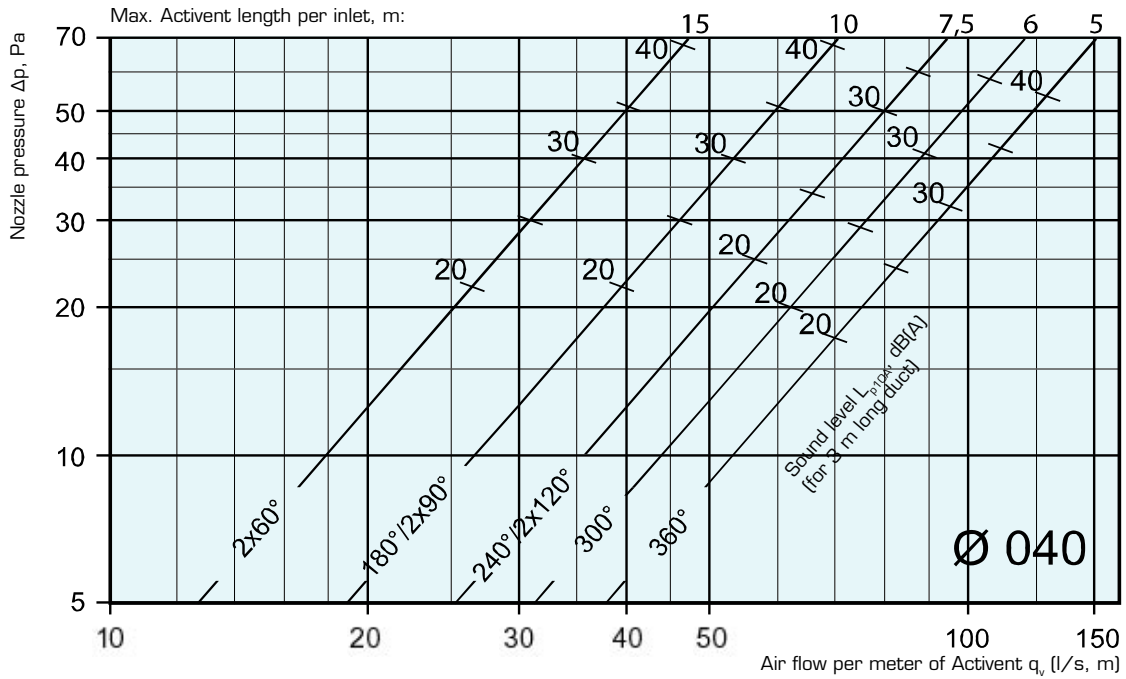

Activent nozzle ducts, size O50, diameter 500 mm

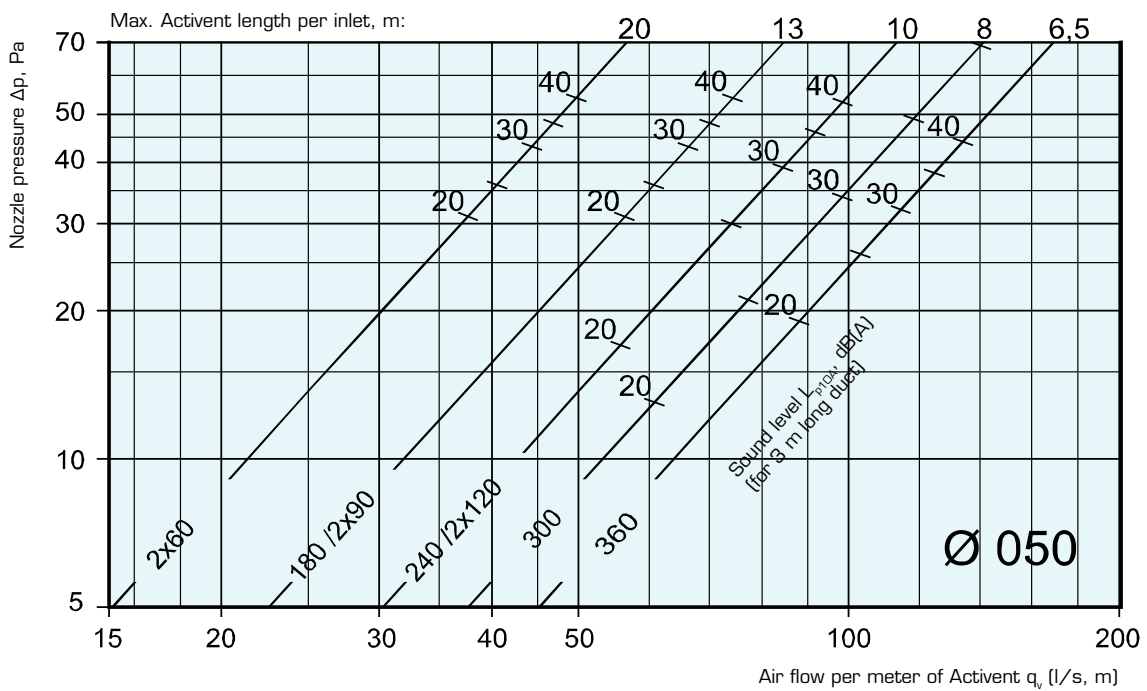

Sound levels

Calculating sound levels

The sound effect in each octave band is obtained by adding the sound pressure level L_{p10A} , dB(A), to the correction factors in the tables:

$$L_{w_{oct}} = L_{p10A} + K_{oct}$$

The sound pressure level L_{p10A} refers to A-filtering and an attenuation of 4 dB (10 m² room absorption area) for each octave band.

Activent Ø 031 - 240° - 3000

Noz. press. p_s	Flow q_v	Sound press. level L_{p10A} dB(A)	Octave band (Hz)							
			125	250	500	1000	2000	4000	8000	
(Pa)	(l/s,m)		Correction factor K_{oct} (dB)							
20	40	21	3	2	5	-5	-13	-18	-15	
40	57	30	1	2	3	-1	-8	-16	-17	
60	70	36	-1	1	1	1	-5	-11	-19	

Activent Ø 020 - 240° - 3000

Noz. press. p_s	Flow q_v	Sound press. level L_{p10A} dB(A)	Octave band (Hz)							
			125	250	500	1000	2000	4000	8000	
(Pa)	(l/s,m)		Correction factor K_{oct} (dB)							
20	25	22	4	8	3	-3	-11	-19	-14	
40	36	33	-1	6	3	-1	-7	-16	-21	
60	44	40	-4	4	3	0	-5	-15	-26	

Activent Ø 040 - 240° - 3000

Noz. press. p_s	Flow q_v	Sound press. level L_{p10A} dB(A)	Octave band (Hz)							
			125	250	500	1000	2000	4000	8000	
(Pa)	(l/s,m)		Correction factor K_{oct} (dB)							
20	57	16	10	1	4	-1	-11	-10	-12	
40	72	28	2	2	2	0	-7	-9	-15	
60	88	35	-2	2	1	0	-5	-9	-17	

Activent Ø 025 - 240° - 3000

Noz. press. p_s	Flow q_v	Sound press. level L_{p10A} dB(A)	Octave band (Hz)							
			125	250	500	1000	2000	4000	8000	
(Pa)	(l/s,m)		Correction factor K_{oct} (dB)							
20	30	18	4	5	4	-2	-10	-12	-12	
40	43	29	3	4	2	-1	-5	-9	-21	
60	52	36	3	4	1	-1	-3	-8	-28	

Activent Ø 050 - 240° - 3000

Noz. press. p_s	Flow q_v	Sound press. level L_{p10A} dB(A)	Octave band (Hz)							
			125	250	500	1000	2000	4000	8000	
(Pa)	(l/s,m)		Correction factor K_{oct} (dB)							
20	61	21	13	7	4	-15	-18	-18	-18	
40	86	30	6	2	1	0	-4	-10	-24	
60	105	44	-7	-10	-10	1	-1	-10	-30	

Sound generated in long Activent

The sound level in the diagrams is given for 3 m long Activent. Use one of the following formulas for ducts longer than 3 m (l = duct length):

size 020 and 025:

$$L_{p10A} = L_{p10A}(3 \text{ m Activent}) + 7 \times (l-3)$$

size 031, 040 and 050:

$$L_{p10A} = L_{p10A}(3 \text{ m Activent}) + 10 \log(l/3).$$

Sound generated by ducts shorter than 3 m is shown in the diagrams (the sound level will not be lower).

Computer software should be used for precise sound calculations. Contact your nearest Fläkt Woods office.

Example

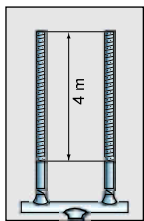

There are two 4 m long Activent ducts in the room: 025 - 240° - 4000. The air flow is 280 l/s or 280/8=35 l/s, m. Sound generated in ducts longer than 3 m is calculated for this size with the following formula (l = Activent length):

$$L_{p10A} = L_{p10A}(3 \text{ m Activent}) + 7 \times (l-3)$$

The diagram on page 7 gives: $L_{p10A}(3 \text{ m Activent}) = 22 \text{ dB(A)}$.

$$L_{p10A}(4 \text{ m Activent}) = 22 \text{ dB(A)} + 7 \times (4-3) \text{ dB(A)} = 29 \text{ dB(A)}$$

Any increased sound levels caused by T-piece and dampers should be included in the calculation.

The total sound level for two Activent is calculated according to general sound calculation rules and the actual room attenuation.

Sound attenuation and assembly

Sound attenuation

The Activent duct's inherent ability to attenuate sound is measured in accordance with ISO 7235. The figures in the table are in accordance with standards for end reflections (SFS 5331) in suspended installations.

Size and nozzle section	Octave band, mean frequency (Hz)							
	63	125	250	500	1000	2000	4000	8000
O20 - 300°	18	15	5	4	5	6	7	13
O25 - 300°	17	10	3	3	4	6	7	11
O31 - 300°	14	8	2	4	2	6	8	14
O40 - 300°	12	7	1	0	3	6	9	14
O50 - 300°	8	4	3	3	5	7	7	14

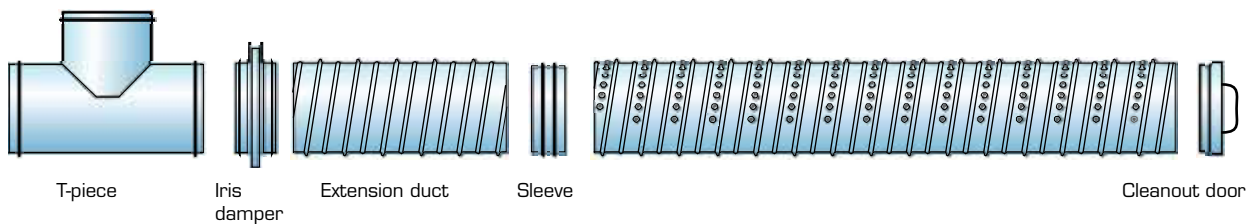

Fittings

Activent deliveries come complete with a range of fittings, such as T-piece, extension ducts, sleeves and end caps. All fittings are supplied in a colour matching the duct's colour. End caps can be ordered as cleanout doors with a handle for easy

removal during duct cleaning. Activent ducts longer than 3 m are supplied in several sections. For example, a 5 m long duct is supplied in two 2,5 m lengths.

Suspension

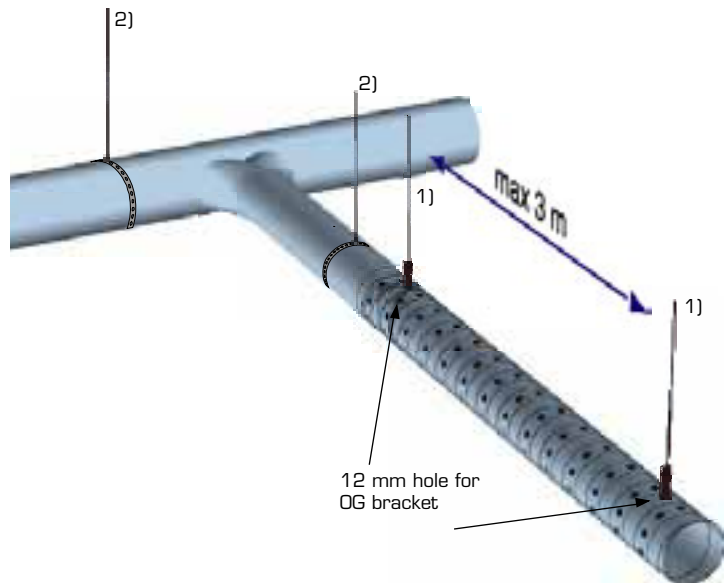
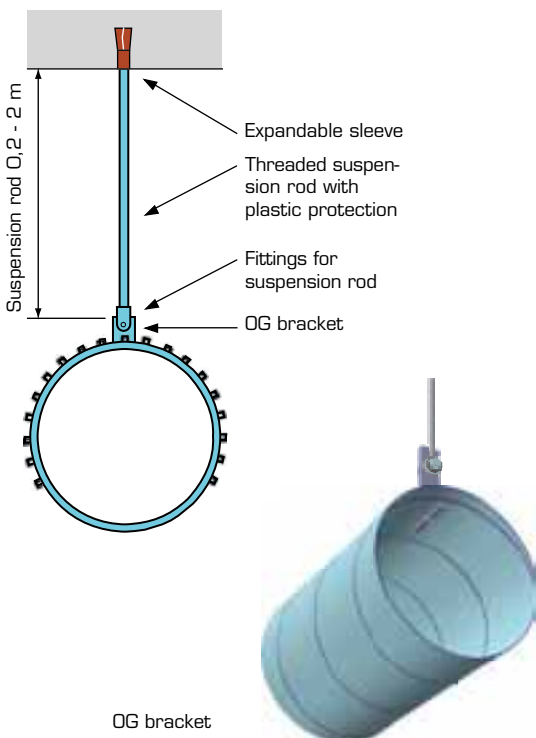

1) Activent support (OG brackets)

2) Main duct support: Main duct is supported in a way that the duct does not put strain on the OG brackets.

Dimensions and codes

Dimensions and weights

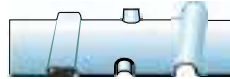
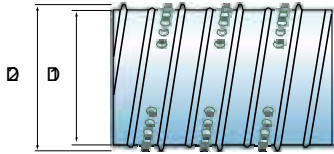

Nozzles are punched out of Activent ducts

Activent size	D1 (mm)	D2 (mm)	Weight (kg/m)
020	200	215	4,8
025	250	265	5,8
031	315	330	7,4
040	400	415	9,3
050	500	515	11,6

Packaging

Each Activent nozzle duct is packed individually in a special cardboard box to protect the nozzles during transportation. The box sizes are given in the table.

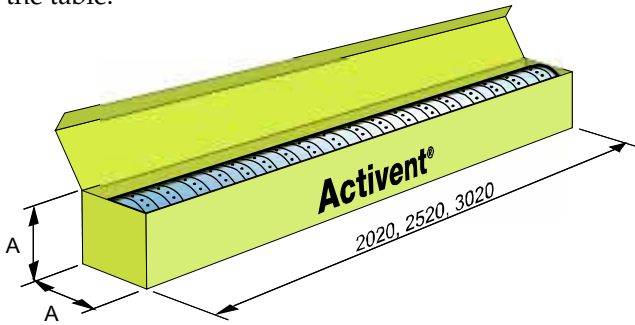

Activent size	A (mm)	Volume (m ³)		
		2020	2520	3020
020	230	0,11	0,13	0,16
025	280	0,16	0,20	0,24
031	345	0,24	0,30	0,36
040	430	0,37	0,47	0,56
050	530	0,57	0,71	0,85

Ordering codes

Activent 031 - 240° - 2000 - 3

Size (cm) _____
020, 025, 031, 040, 050

Nozzle degrees _____
360°, 300°, 240°, 180°, 2x120°, 2x60°, 0° (extension duct)

Standard lengths (mm) _____
2000, 2500, 3000
Customised lengths can be supplied up to 3000 mm

Materials and paint finish _____
1 = Hot galvanised steel
3 = Hot galvanised steel, finished with polyeste powder paint. Standard colour RAL 9010 (white) or special colour
4 = Extension duct

Accessories

(Specified separately)

Sleeves	BDEN-1-
End caps	BDEG-4-
Cleanout doors	XDEG-4-
Transition pieces	BDEM-1-
T-pieces	BDET-1-
Bends	BDEB-90-
Adjustment damper	IRIS-
OG brackets	

We Bring Air to Life

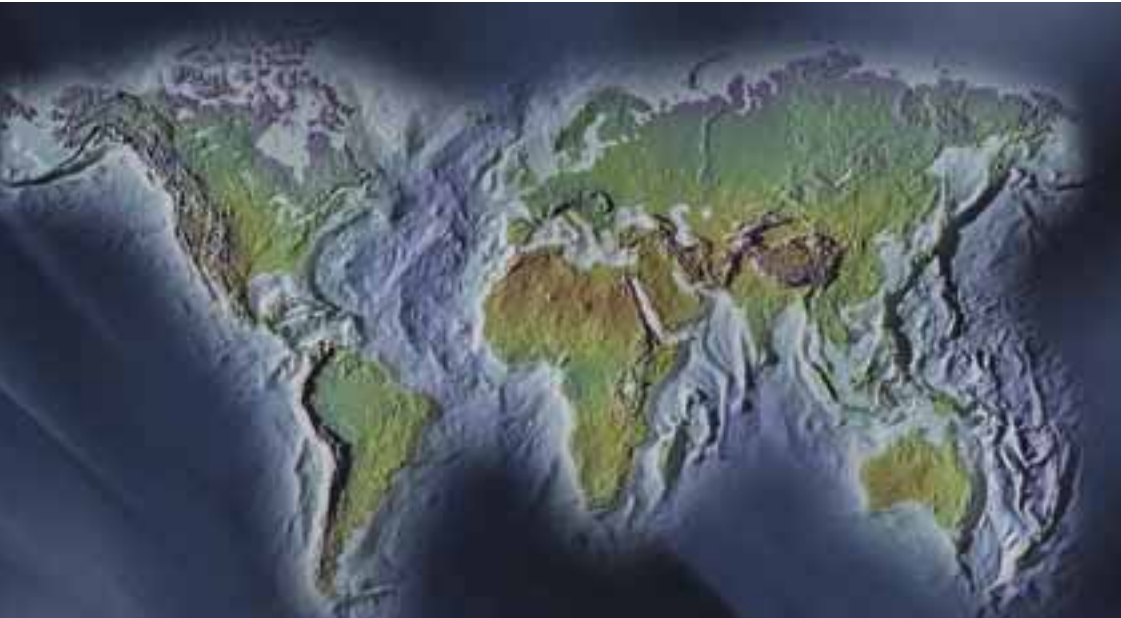

Fläkt Woods Group provides a full range of products and solutions for buildings ventilation, air treatment and industrial air movement

Head office

Fläkt Woods Group Ltd
Affolternstrasse 40
8050 Zürich
Tel: +41 43 288 38 00
Fax: +41 43 288 38 10
Email: info@flaktwoods.com

Sales Offices available World Wide - See our website for details

www.flaktwoods.com

Due to a policy of continuous development and improvement the right is reserved to supply products which may differ from those illustrated and described in this publication. Certified dimensions will be supplied on request on receipt of order.